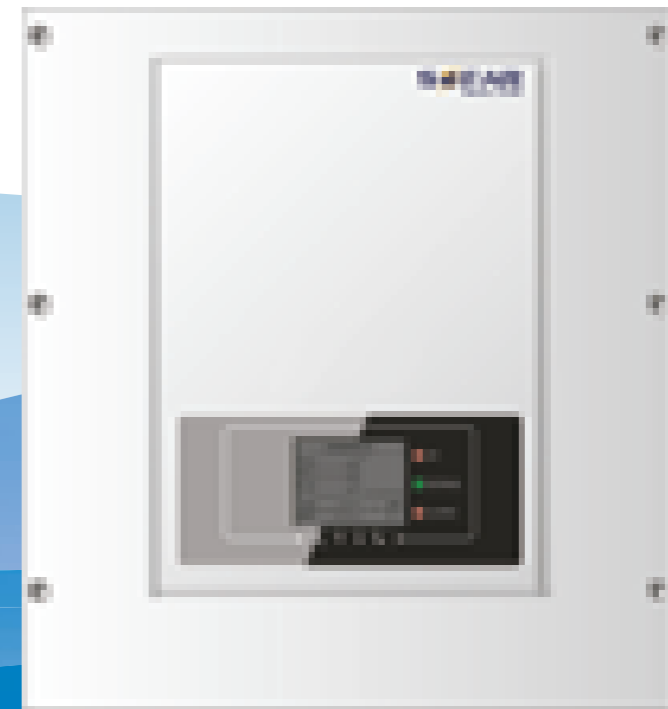


User manual

# PV Grid-Connected Inverter

Product Model: SOFAR 10K-15KTL-G2 (2019.07.31)



## Notice

This manual contains important safety instructions that must be followed during installation and maintenance of the equipment. The product you purchase is restricted by SOFAR SOLAR's commercial invoice. Your product may do not cover the full characteristics or functions described in this document. SOFAR SOLAR does not state/assure the content of this document unless there is special contract agreement.

## Save these instructions!

This manual must be considered as an integral part of the equipment, and must be available at all times to everyone who interacts with the equipment. The manual must always accompany the equipment, even when it is transferred to another user or field.

## Copyright Declaration

The copyright of this manual belongs to Shenzhen SOFARSOLAR Co., Ltd. Any corporation or individual should not plagiarize, partially copy or fully copy it (including software, etc.), and no reproduction or distribution of it in any form or by any means. All rights reserved. SOLARSOFAR reserves the right of final interpretation. This manual is subject to change according to user's or customer's feedback. Please check our website at <http://www.sofarsolar.com> for latest version.

## Shenzhen SOFARSOLAR Co., Ltd.

ADD:401, Building 4, AnTongDa Industrial Park, District 68,XingDong Community,  
XinAn Street, BaoAn District, Shenzhen, Guangdong.P.R. China

[Http://www.sofarsolar.com](http://www.sofarsolar.com)

P. C. : 518000

E-mail: [service@sofarsolar.com](mailto:service@sofarsolar.com)

# Preface

## Outline

Please read the product manual carefully before installation, operation or maintenance. This manual contains important safety instructions and installation instructions that must be followed during installation and maintenance of the equipment.

### • Scope

This product manual describes the assembly, installation, commissioning, and maintenance of the following inverters.

**SOFAR 10000TL-G2 ; SOFAR 12000TL-G2 ; SOFAR 15000TL-G2**






Keep this manual where it will be accessible at all times.

### • Target Group

This manual is for qualified person (support person, service person are qualified mentioned in this manual).

### • Symbols Used

This manual provides safety operation information and uses the symbol in order to ensure personal and property security and use the inverter efficiently when operating the inverter. You must understand these emphasize information to avoid the personal injury and property loss. Please read the following symbols which used in this manual carefully.

 <b>Danger</b>	<b>Danger indicates a hazardous situation which, if not avoided, will result in death or serious injury.</b>
 <b>Warning</b>	<b>Warning indicates a hazardous situation which, if not avoided, could result in death or serious injury.</b>
 <b>Caution</b>	<b>Caution indicates a hazardous situation, if not avoided, could result in minor or moderate injury.</b>
 <b>Attention</b>	<b>Attention indicates there are potential risks. If fail to prevent, may lead to equipment cannot run normally or property damage.</b>
 <b>Note</b>	<b>It also can be some tips to use this product, it can help you to solve some problems and save you time.</b>

# Table of contents








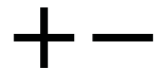
<b>Preface</b> .....	<b>III</b>
<b>1 Basic safety information</b> .....	<b>1</b>
1.1 Symbols .....	1
1.2 Safety instructions and warnings .....	2
<b>2 Product characteristics</b> .....	<b>3</b>
2.1 Intended grid types .....	3
2.2 Interface and Dimensions .....	4
2.3 Protection units .....	6
<b>3 Installation</b> .....	<b>7</b>
3.1 Packing Materials .....	7
3.2 Tools .....	8
3.3 Determining the Installation Position .....	10
3.4 Installing the SOFAR 10K~15KTL-G2 .....	13
<b>4 Electrical Connections</b> .....	<b>14</b>
4.1 Connecting PGND Cables .....	14
4.2 Connecting AC Output Power Cables .....	15
4.3 Connecting Communications Cables .....	17
4.4 Connecting DC Input Power Cables .....	21
4.5 DRMs Functions .....	24
4.6 Safety check .....	26
<b>5 Commissioning of inverter</b> .....	<b>27</b>
5.1 Safety inspection before commissioning .....	27
5.2 Start inverter .....	27

<b>6 Operation interface</b> .....	<b>28</b>
6.1 Operation and Display Panel .....	28
6.2 Standard Interface .....	29
6.3 Main Interface .....	31
<b>7 Trouble shooting and maintenance</b> .....	<b>43</b>
7.1 Trouble shooting .....	43
7.2 Maintenance .....	47
<b>8 Decommissioning</b> .....	<b>48</b>
8.1 Decommissioning steps .....	48
8.2 Package .....	48
8.3 Storage .....	48
8.4 Disposal .....	48
<b>9 Technical data</b> .....	<b>49</b>
9.1 Input parameter (DC) .....	49
9.2 Output parameter (AC) .....	50
9.3 Efficiency, Safety and Protection .....	50
9.4 General Data .....	51
<b>10 Quality Assurance</b> .....	<b>52</b>
10.1 Standard warranty period .....	52
10.2 Extended warranty period .....	52
10.3 Invalid warranty clause .....	52

# Basic safety information

## 1.1 Symbols

10K~15KTL-G2 inveter has some safety related symbol, please make sure you have read and understand these symbol content before you install this equipotent.

Symbol	Symbol name	Meaning
	there is residual voltage danger in inverter.	After turning off inverter DC switch , there is voltage in the inverter capacitor within some time, we suggest you start to open the inverter for maintenance 5 minutes later after you turning off DC switch.
	High voltage , electric shock hazard.	There is high voltage during inverter running , all the operations should be done by quantified professional electrical person.
	High temperate on inverter enclosure Burn Hazard.	High temperature in inverter enclosure when it is running,do not touch.
	CE certificate: this inverter is compilable with CE certificate standard.	This inverter is compilable with CE certificate standard.
	PE connection symbol.	Connect inverter with earth terminal for protection.
	Temperature sysbol.	Inverter working temperature range.
	Ingress protection symbol.	This product has IP65.
	Electrical positive and negative.	Be care of electrical polarity.

## 1.2 Safety instructions and warnings

Operator must follow bellowing safety instructions when he installs 10K~15KTL-G2 series inverter ,incorrect operation may cause property loss, equipments damage or personal injury.

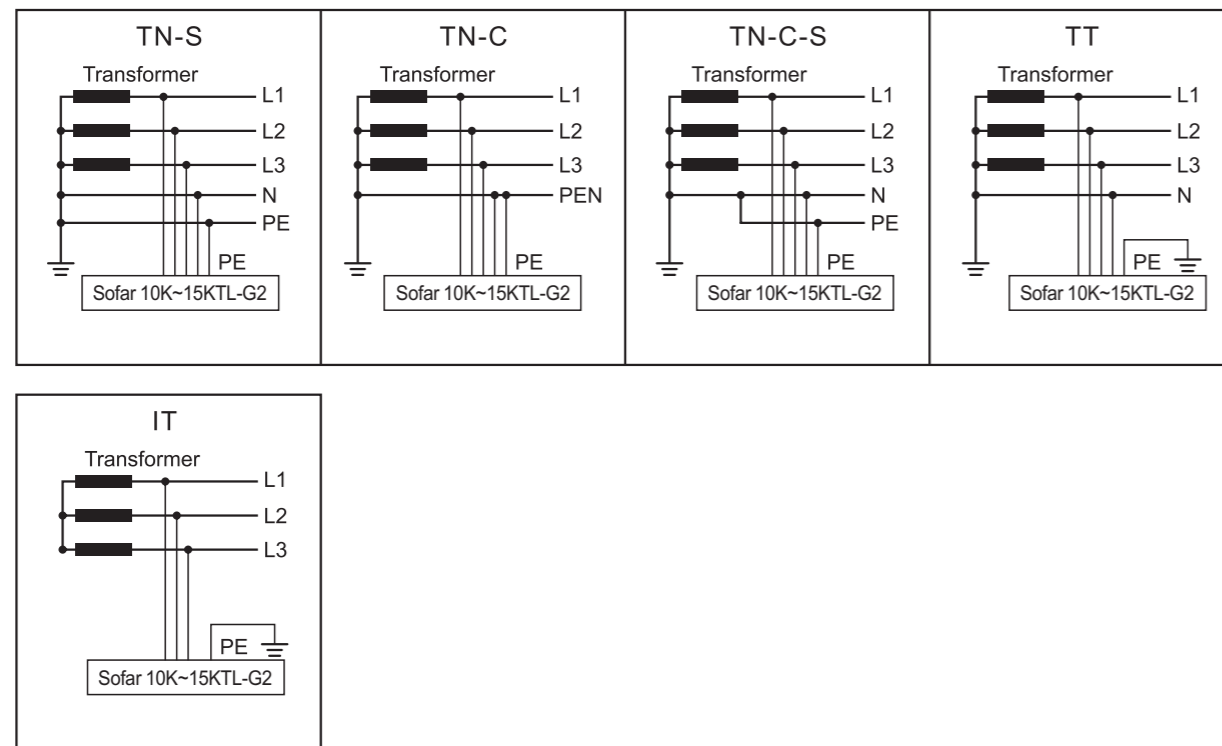
1. Inverter can be installed only by professional electrician or electrical engineer according to local standard and regulations. Only after getting permission from local power department, inverter can be connected on grid.
2. DC and AC switch must be turned off when installing and maintaining inverter. Can not touch inverter metal part with 5 minutes after inverter turning off.
3. Some part of inverter may be higher than 60 degree when it is running, please do not touch its metal part to avoid burn injury.
4. It is forbidden to plug off DC or AC connector when inverter is in generation.
5. Please do not open the inverter upper case, touch or remove inside components ,it may cause inverter damage or personal injury.
6. 10-15KW-G2 series inverter are transformer-less no-isolated inverter , the PV modules connected with Sofar inverter should be compatible with IEC 61730 Class A.

# 2 Product characteristics

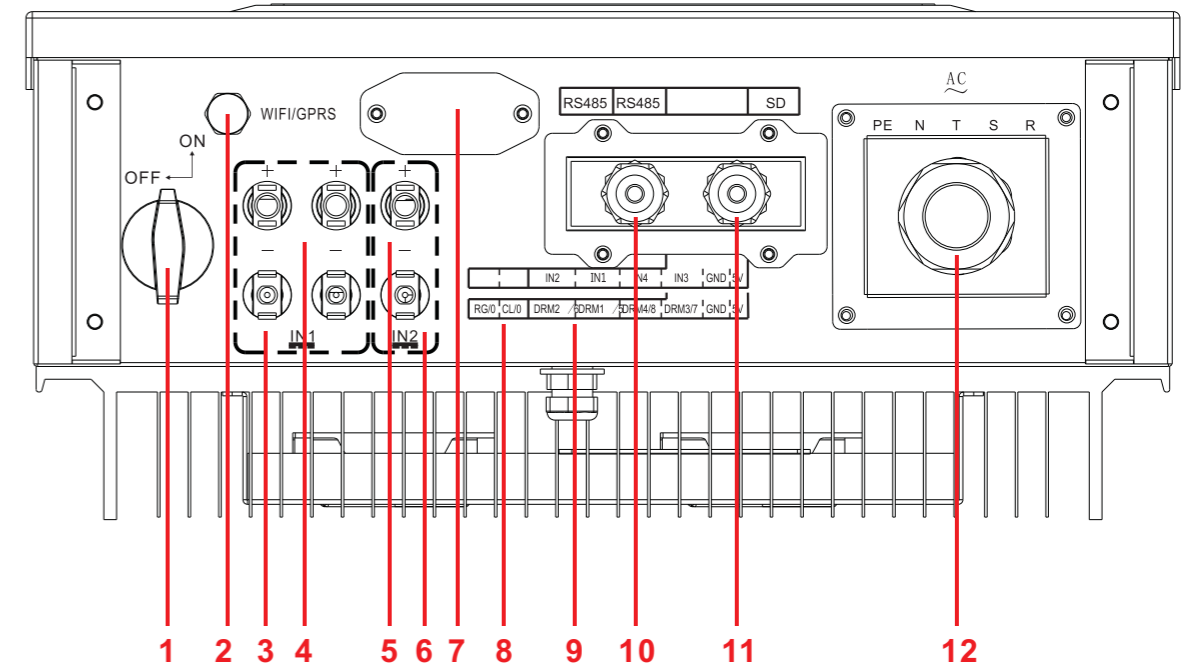
## 2.1 Intended grid types

Sofar 10K~15KTL-G2 inverters are compatible with TN-S、TN-C、TN-C-S、TT、IT grid configurations。For the TT type of electricity grid, the voltage between neutral and earth should be less than 30V.

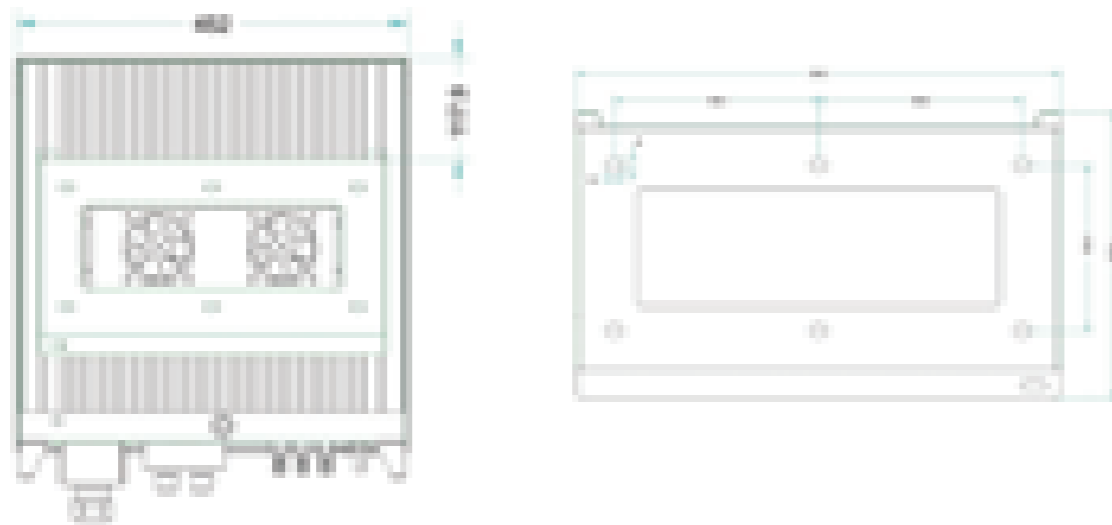
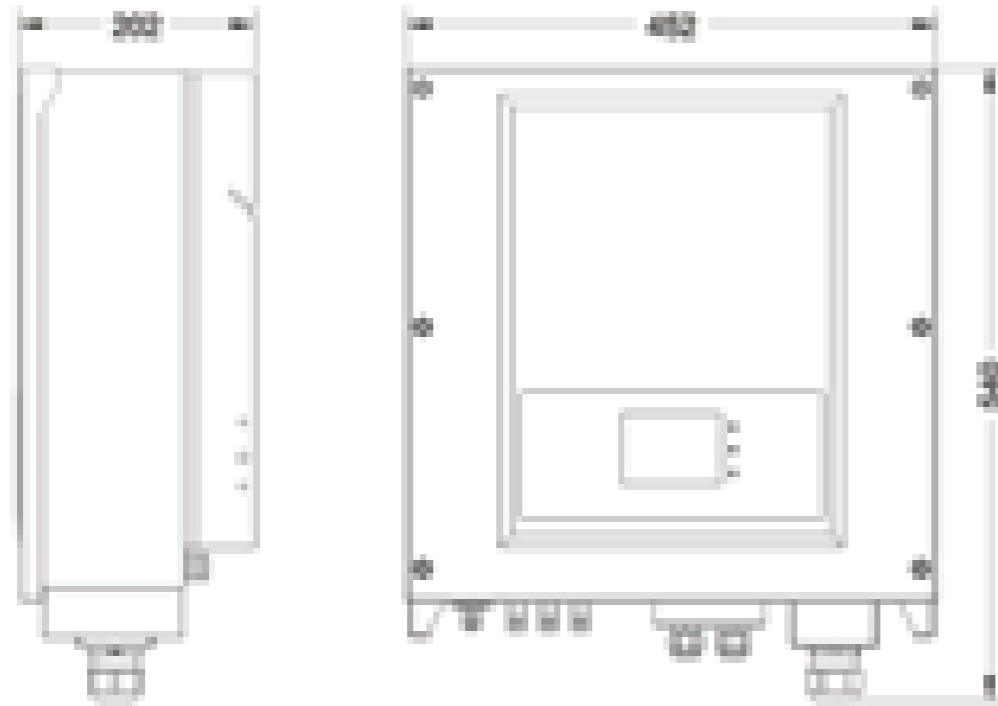
Figure2-2 Overview of the grid configurations



## 2.2 Interface and Dimensions



- 1, DC Switch
- 2, Vent valve
- 3-6, DC connector (DCV C)
- 7, WIFI/GPRS (DCV A)
- 8, DRM0 (DCV A)
- 9, DRM5~8 & External digital inputs (DCV A)
- 10-11, RS485 (DCV A)
- 12, AC output connector (DCV C)



1, Inverter front 2, Inverter side 3, Inverter back 4, Installation rack

## 2.3 Protection units

### A. RCMU

When inverter's leakage current exceeds safety requirement, inverter will stop generation

### B. Grid abnormal protection

When inverter detects the grid or voltage is out of range, inverter will stop generation. Inverter will restart to generation automatically when the grid is normal again

### C. Ground fault detecting

When ground fault happen, inverter will stop generation automatically and the GFI red LED will be on to inform customer.

### D. Over temperature de-rating

When temperature is higher than internal setting, inverter will derate the power automatically

### E. Over voltage de-rating

When MPPT point is higher than 850V, inverter will derate the power automatically

### F. Over current protection

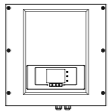
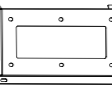


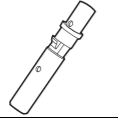
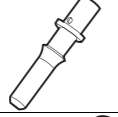
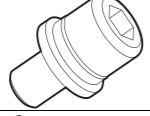
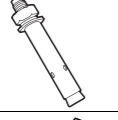



When inverter is abnormal, overcurrent protection can protect inverter from damage

### G. Reverse connection protection

# 3 Installation

## 3.1 Packing Materials

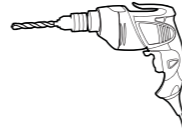
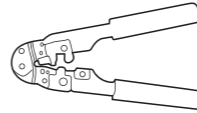
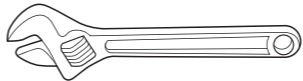

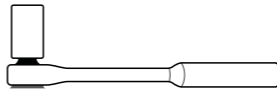



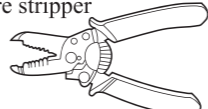
Table3-1 shows the components and mechanical parts that should be delivered

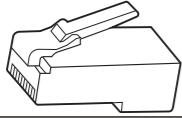
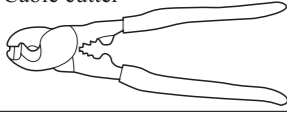

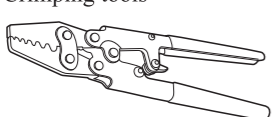
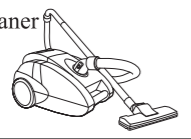
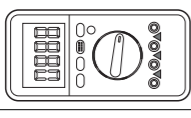

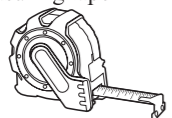
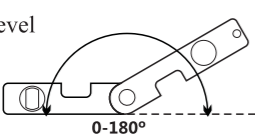
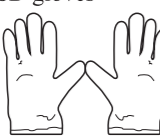


No.	Pictures	Quantity	Description
1		1PCS	Sofar 10K~15KTL-G2
2		1PCS	Rear panel
3		3PCS	DC+ input terminal
4		3PCS	DC- input terminal
5		3PCS	Metal terminals secured to DC+ input power cables
6		3PCS	Metal terminals secured to DC- input power cables
7		3PCS	M6 Hexagon screws
8		6PCS	M8*80 Expansion bolts used to secure the rear panel to the wall
9		1PCS	Manual
10		1PCS	The warranty card
11		1PCS	Certificate

## 3.2 Tools

Prepare tools required for installation and electrical connections.

Table3-2 Shows the components and mechanical parts that should be delivered

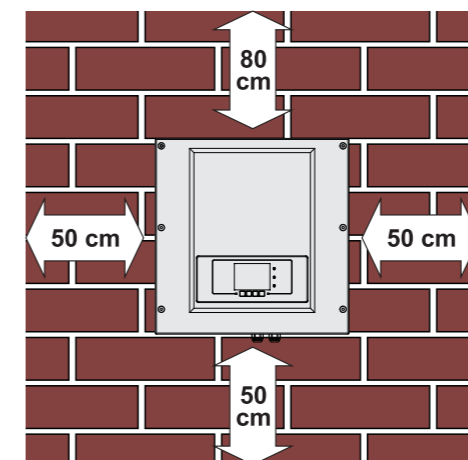
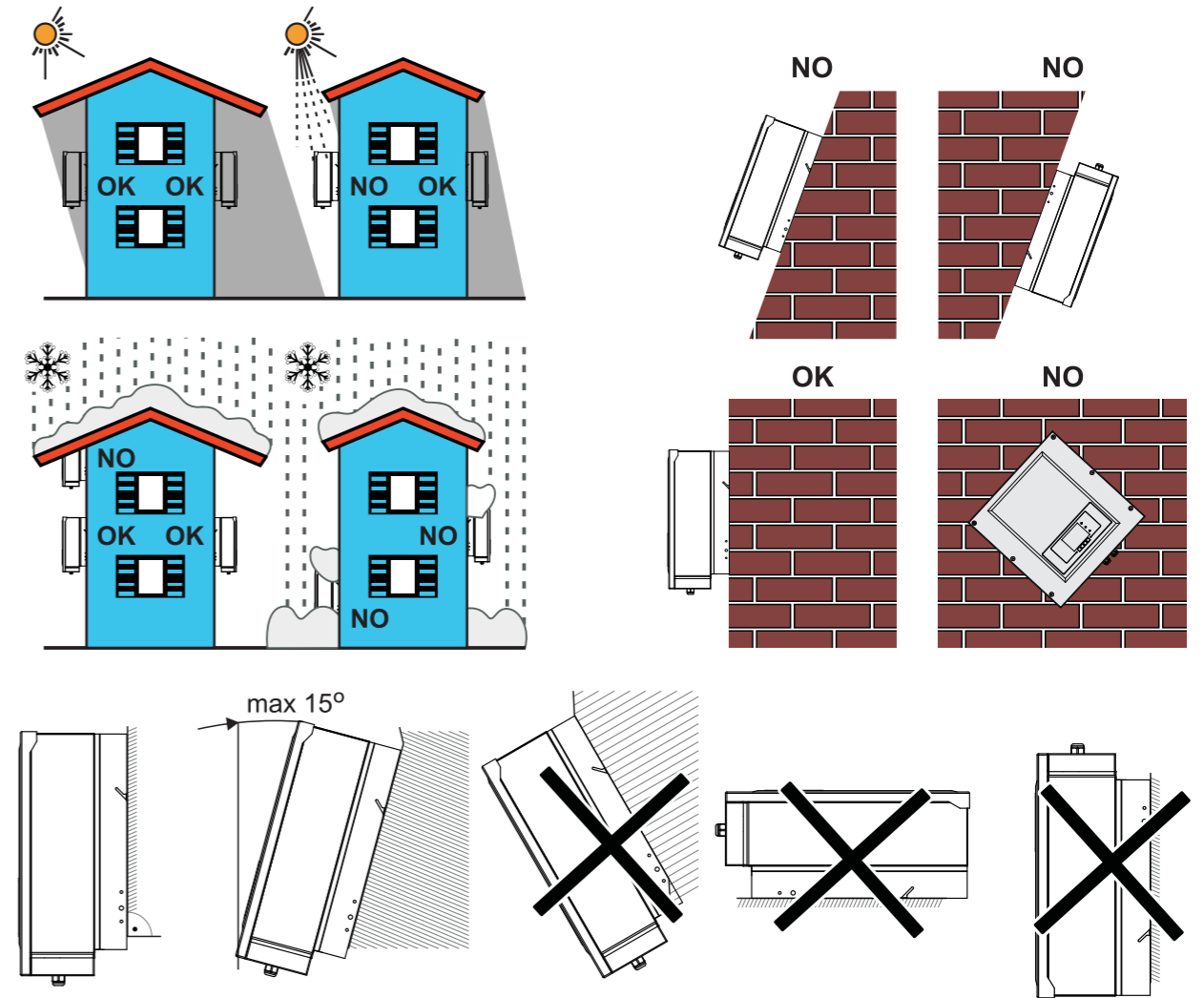
Tool	Model	Function
Hammer drill 	With a drill bit of $\Phi 8.0$	Used to drill holes on the wall
RJ45 crimping tool 	N/A	Used to prepare RJ45 connectors for Communications cables
Adjustable wrench 	With an open end of larger than or greater than 32 mm	Used to tighten expansion bolts
Flat-head screwdriver 	M4	<ul style="list-style-type: none"> <li>Used to tighten or loosen screws when installing AC power cables.</li> <li>Used to remove AC connectors from the Sofar 10K~15KTL-G2.</li> </ul> Note: The torque screwdriver and flat-head screwdriver are alternative.
Socket wrench 	M5	Used to tighten ground bolts
Rubber mallet 	N/A	Used to hammer expansion bolts into holes
Removal tool 	N/A	Used to remove DC connectors from the Sofar 10K~15KTL-G2
Diagonal pliers 	N/A	Used to cut and tighten cable ties
Wire stripper 	N/A	Used to peel cable jackets

Tool	Model	Function
	RJ45	2PCS
Cable cutter 	N/A	Used to cut power cables
Hexagon socket 	Diameter 2.0mm Diameter 5.0mm	Hexagon socket use to uninstall and install the front top cover and down cover.
Crimping tools 	N/A	Used to crimp power cables
Vacuum cleaner 	N/A	Used to clean up dusts after drilling holes
Multimeter 	N/A	Used to check grounding
Marker 	N/A	Used to mark signs
Measuring tape 	N/A	Used to measure distances
Level 	N/A	Used to ensure that the rear panel is properly installed
ESD gloves 	N/A	Operators wear ESD gloves when installing equipment.
Safety goggles 	N/A	Punch operator wearing
Anti-dust respirator 	N/A	Punch operator wearing

### 3.3 Determining the Installation Position

Determine an appropriate position for installing the Sofar 10K~15KTL-G2. Comply with the following requirements when determining the installation position:

Figure 3-2 Installation position requirements



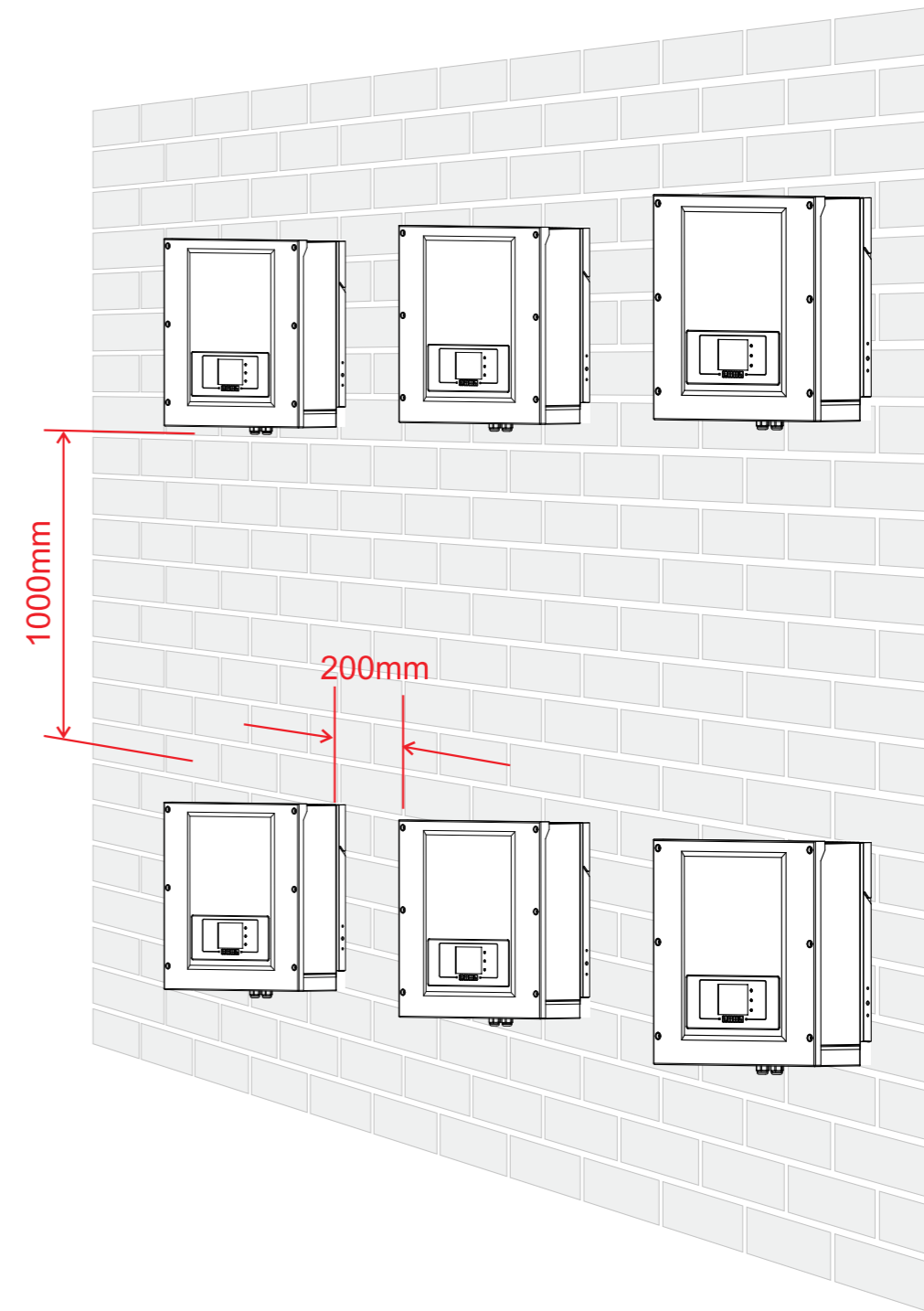
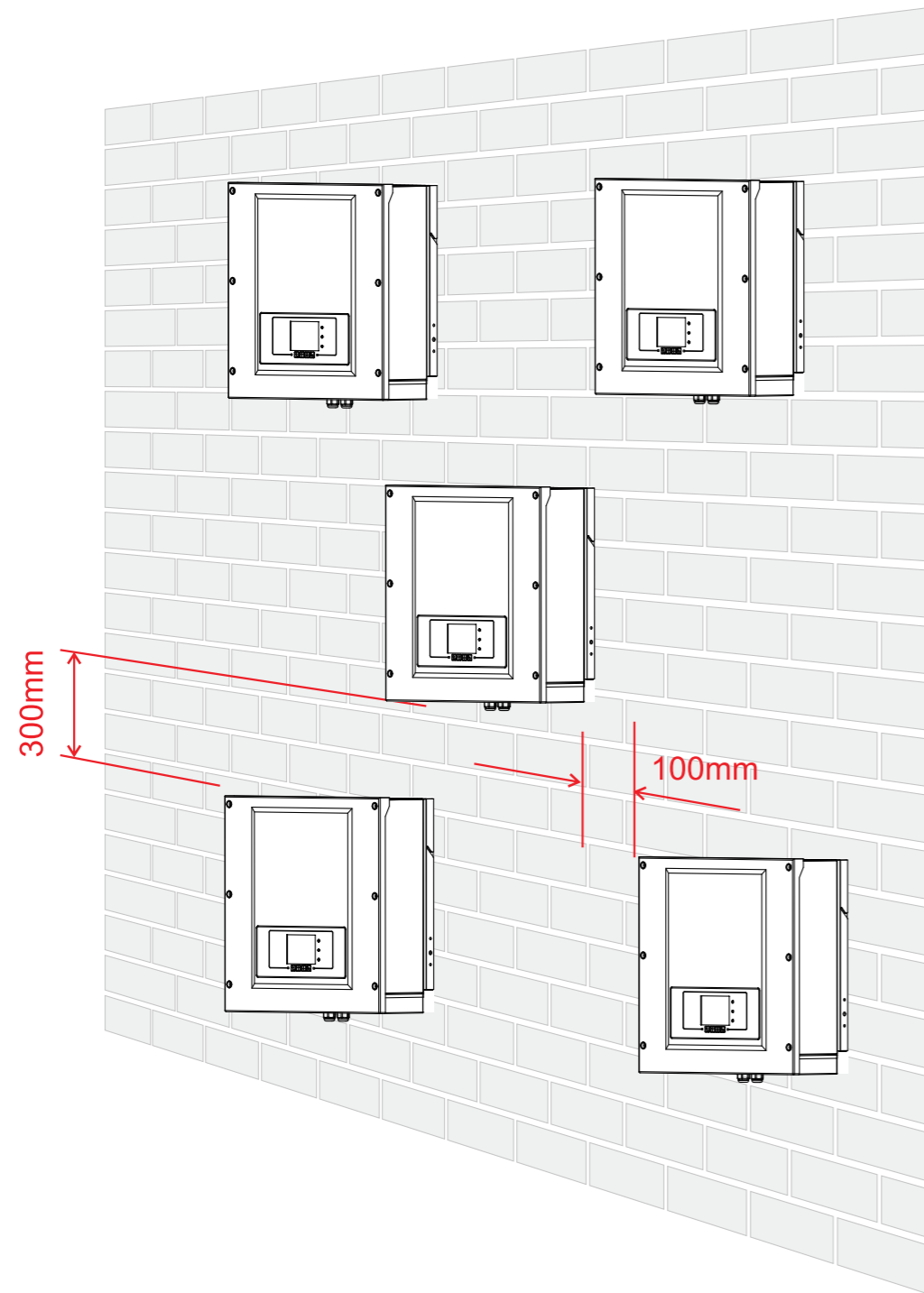
Minimum installation distance for Sofar 10K~15KTL-G2

Installation position requirements

1. It should be easy to cut off the power supply
2. The wall should have enough strength to support inverter
3. Can not be touched by child

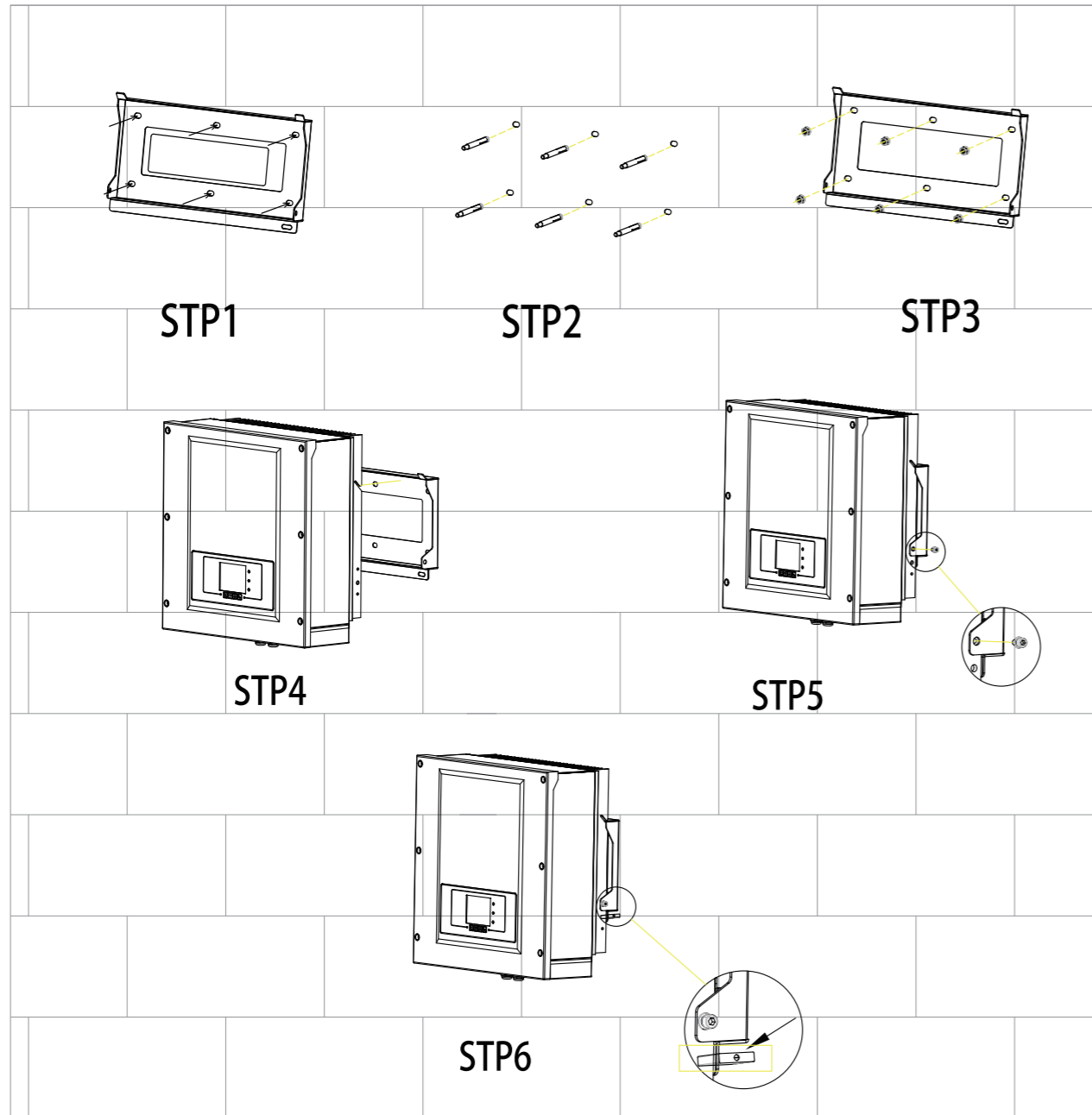


Figure 3-3 Many Sofar 10K~15KTL-G2 installation



### 3.4 Installing the Sofar 10K~15KTL-G2

Figure 3-4



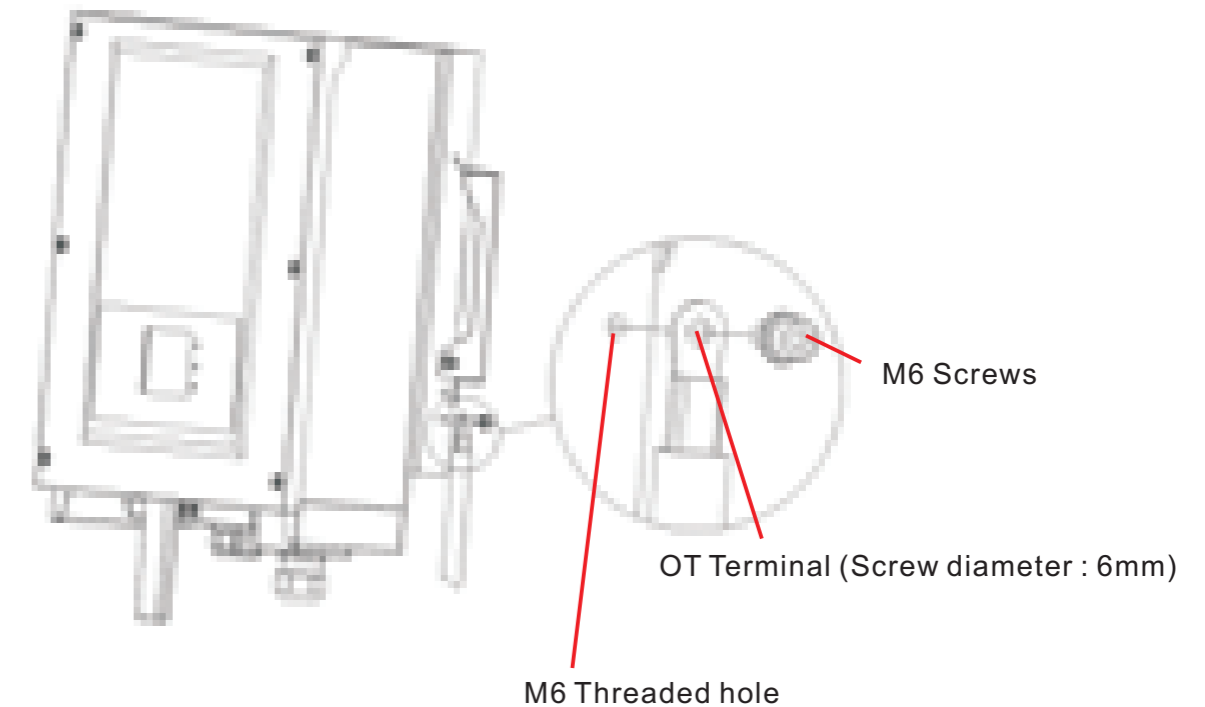
- 1, Mark and drilling hole    2, Insert expansion bolts    3, install rack    4, put on inverter  
 5, Install fix screw    6, Lock the inverter(if necessary)

# 4 Electrical Connections

## 4.1 Connecting PGND Cables

1. Make sure the inverter DC switch is in OFF status
2. Check if the grid voltage and frequency are in correct range
3. If the PV panel is thin-film panel, a transformer (1.25 times as inverter capacity) should be added at AC side
4. PE cable should be thicker than 4mm and reliable,


Figure 4-2 Ground terminal composition



## 4.2 Connecting AC Output Power Cables

Cable and breaker selection

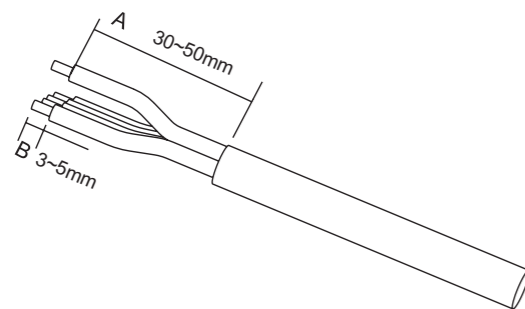
Model	SOFAR 10000TL-G2	SOFAR 12000TL-G2	SOFAR 15000TL-G2
Cable(Copper)	4-6mm <sup>2</sup>	4-6mm <sup>2</sup>	4-6mm <sup>2</sup>
Breaker	32A	32A	32A

 <b>Note</b>	<p>For safety requirement, please use the quantified cable , or it may cause cavle over heat even fire                      The leakage current of breaker should be higher than 100mA and lower than 300mA</p>
--	---

Cross area (mm <sup>2</sup> )	Maximum cable length (m)		
	SOFAR 10000TL-G2	SOFAR 12000TL-G2	SOFAR 15000TL-G2
4	32	25	20
6	48	43	34

### AC cable installation steps

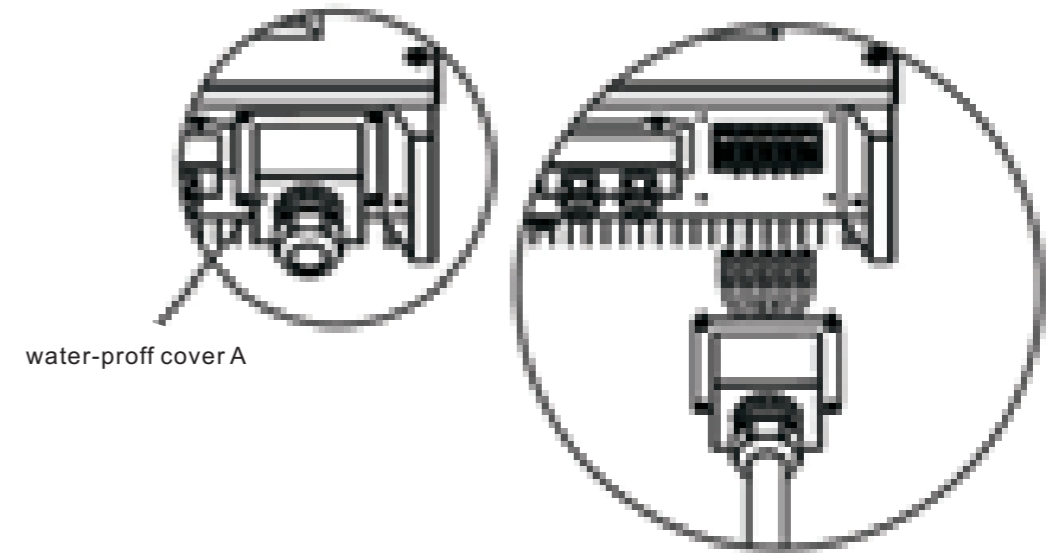
10K~15KTL-G2 is three phase output inverter, it complies with related on-grid standard and safety requirements.



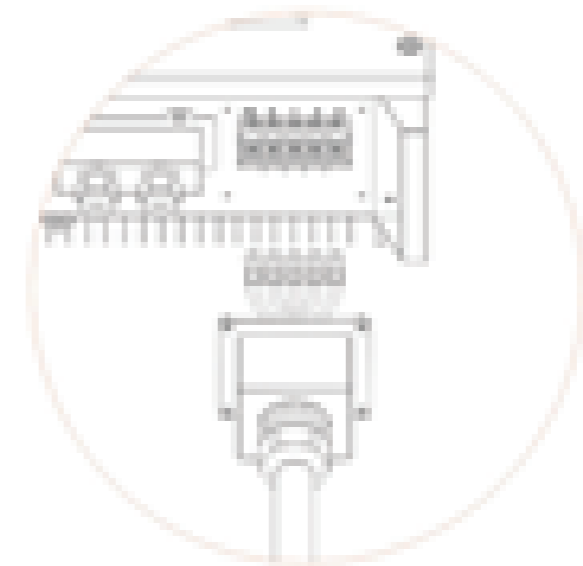
A. part cable length 30-50mm  
 B. part cable length 3-5mm



Isolation cover and terminals can not be exposed



Crimp each core cable to OT terminal(KST, RNBL5-4 is recommended), after fixing , use isolation tape to cover exposed part of OT(except O part).



Connect OT terminal to AC connector according to the painting then fix the water-proof cover.

### 4.3 Connecting Communications Cables

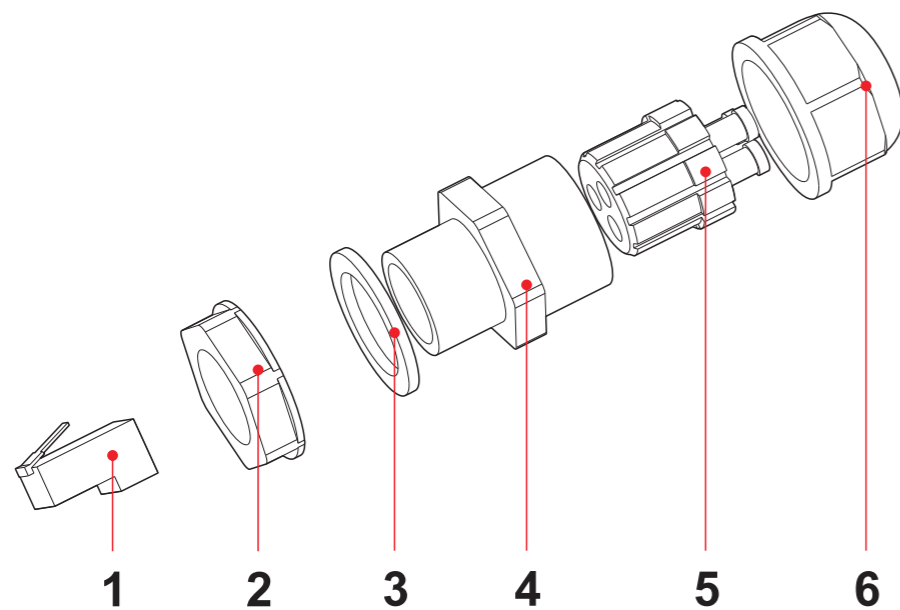
#### Connecting RS485 Communications Cables

By the RS485 communication line, connecting Sofar 10K~15KTL-G2 to communication equipment (such as data acquisition, PC terminal).

You are recommended to use 24 AWG outdoor shielded network cables with the internal resistance less than or equal to 1.5 ohms/10 m and external diameter of 4.5 mm to 7.5 mm as RS485 communications cables.

A waterproof RJ45 connector has six parts: plug, screw nut, seals, housing, sealing plug and cable screw nut, as shown as follow.

Figure 4-6 Waterproof RJ45 connector composition



1. Plug 2. Screw nut 3. Seals 4. Housing 5. Sealing Plug 6. Cable Screw nut

When routing communications cables, ensure that communications cables are separated from power cables and away from interference sources to prevent communication interruptions.

### Procedure

**Step 1** Remove the insulation layer of an appropriate length from the shielded network cable using a wire stripper.

**Step 2** Open Sofar 10K~15KTL-G2 lower cover and insert the shielded network cable into the cable screw nut, seals, screw nut.

**Step 3** Connect the stripped network cable to corresponding pins on the plug, as shown as follow.

Figure 4-7 RS485 Connecting Communications Cables(1)

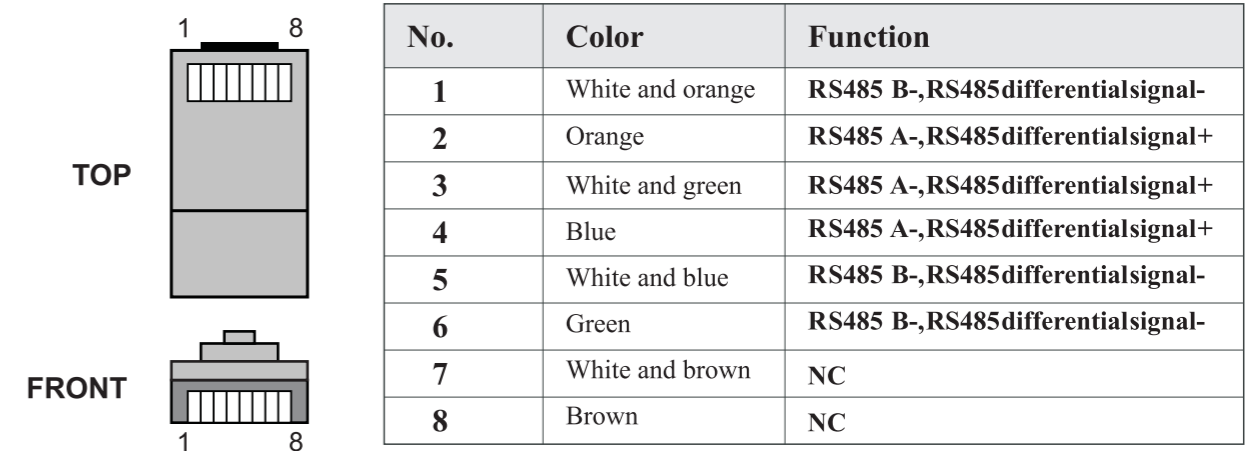
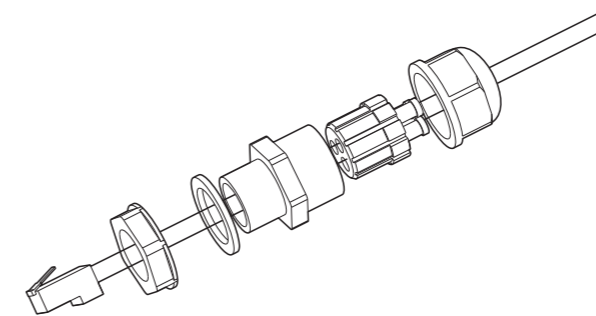


Figure 4-8 RS485 Connecting Communications Cables(2)

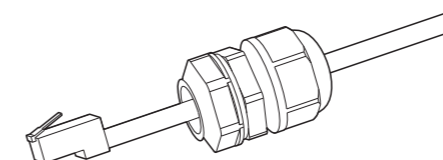


**Step 4** Crystal plug with RJ45 crimping tool.

**Step 5** Insert the plug into the RS485 port on the Sofar 10K~15KTL-G2.

**Step 6** Insert sealing plug into housing.

Figure 4-9 RS485 Connecting Communications Cables(3)



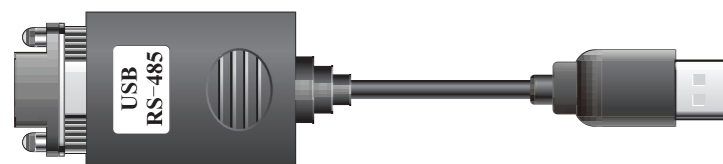
## Communications Port Description

This topic describes the functions of the RS485 and WIFI ports.

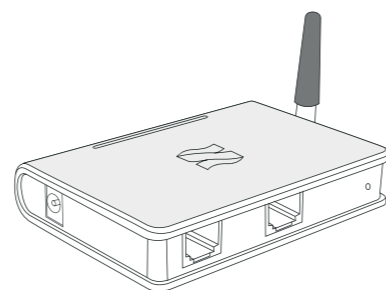
### RS485

By RS485 interface, transfer the inverter power output information, alarm information, operation state to the PC terminal or local data acquisition device , then uploaded to the server (such as TERMINAL).

#### 1. USB-RS485

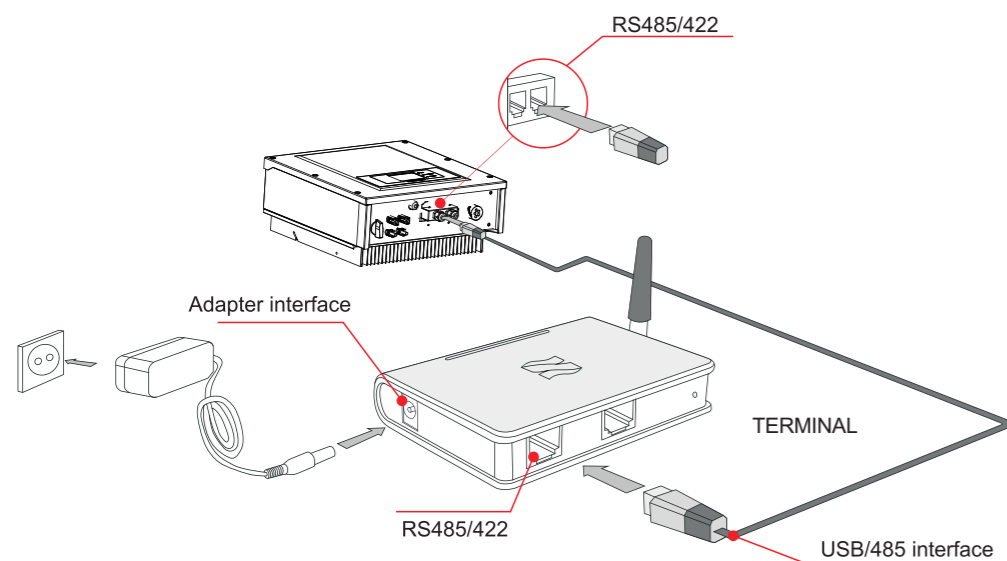


#### 2. TERMINAL



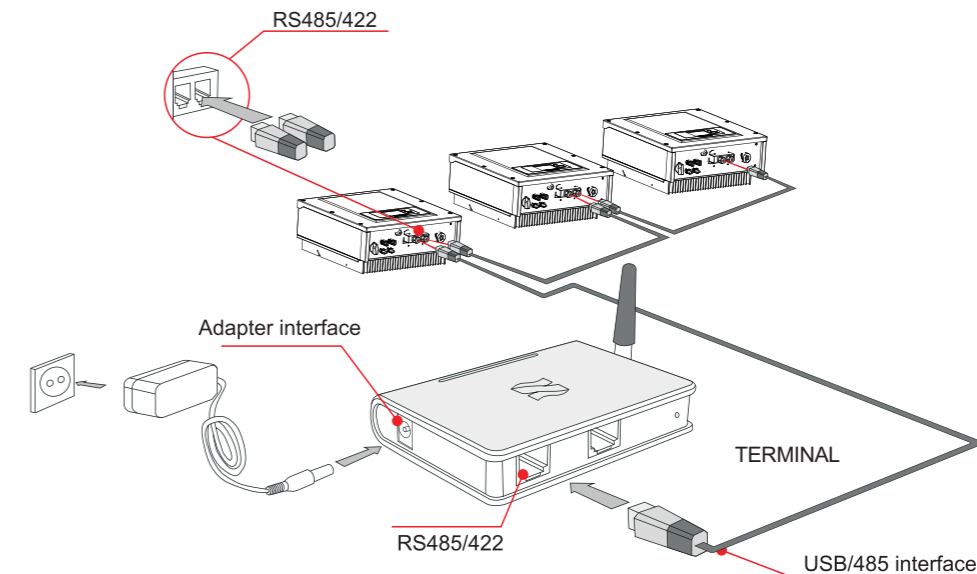
If only one Sofar 10K~15KTL-G2 is used, use a communication cable with waterproof RJ45 connectors, and choose either of the two RS485 ports.

Figure 4-10 A single Sofar 10K~15KTL-G2 connecting Communications



If multiple Sofar 10K~15KTL-G2 are used, connect all Sofar 10K~15KTL-G2 in daisy chain mode over the RS485 communication cable.

Figure 4-11 Multi Sofar 10K~15KTL-G2 connecting Communications



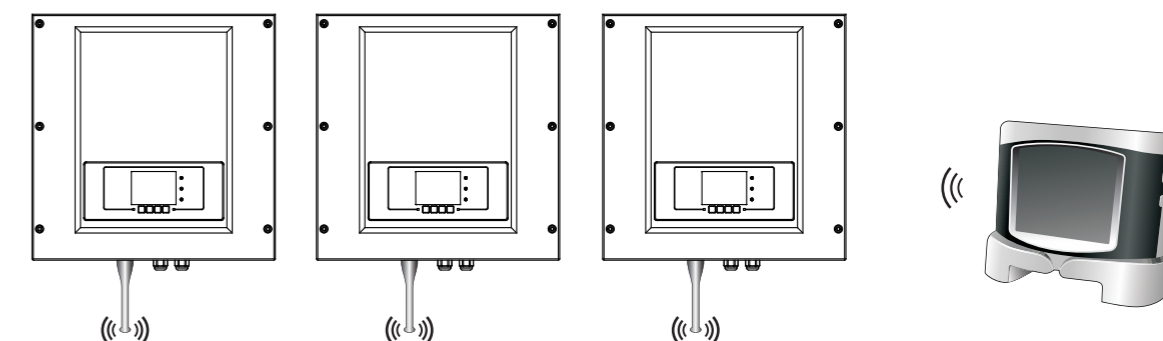
According to the manufacturers to provide SN number can register remote monitoring of

### WiFi/GPRS

By the WIFI interface, transfer the inverter power output information, alarm information, operation state to the PC terminal or local data acquisition device , then uploaded to the server (such as TERMINAL).

According to the manufacturers to provide SN number can register remote monitoring of Sofar 10K~15KTL-G2 through <http://www.solarmanpv.com>.

Figure 4-12 Connect multiple Wifi to wireless router



#### Note

- The length of the RS485 communication cable should be less than 1000 m.
- The distance between WIFI and Ethernet router should be less than 100m.
- If multiple Sofar 10K~15KTL-G2 are connected to the monitoring device over an RS485/RS232 converter, a maximum of 31 inverter can be connected in a daisy chain.

## 4.4 Connecting DC Input Power Cables

The positive and negative poles of the panel to inverter need to connect fuse separately. The electric wire should choose PV cable, from the junction box to the inverter, line voltage drop is about 1~2%, The inverter is installed in the PV bracket, which saves the cable and reduce the DC loss.

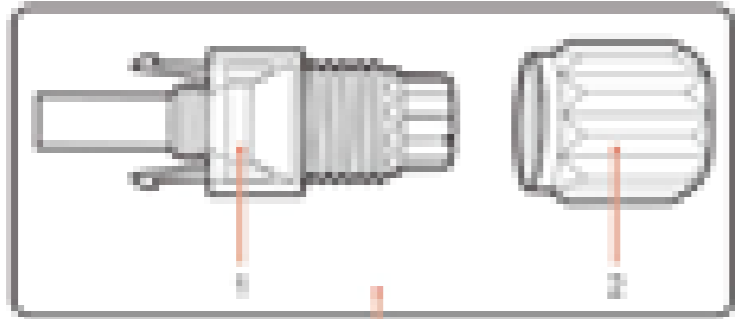
### Context

Table 4-3 Recommended DC input cable specifications

Cross-Sectional Area (mm)		External Cable Diameter(mm)
Range	Recommended Value	
4.0~6.0	4.0	4.5~7.8

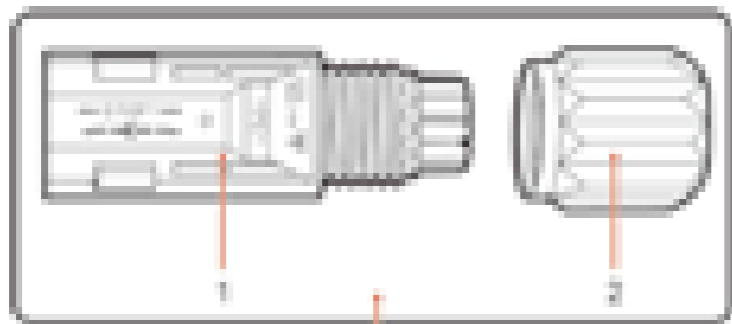
DC input connectors are classified into positive and negative connectors, as shown in Figure 4-13 and Figure 4-15.

Figure 4-13 Positive connector composition



1. Housing 2. Cable gland 3. Positive connector

Figure 4-14 Negative connector composition



1. Housing 2. Cable gland 3. Negative connector



### Note

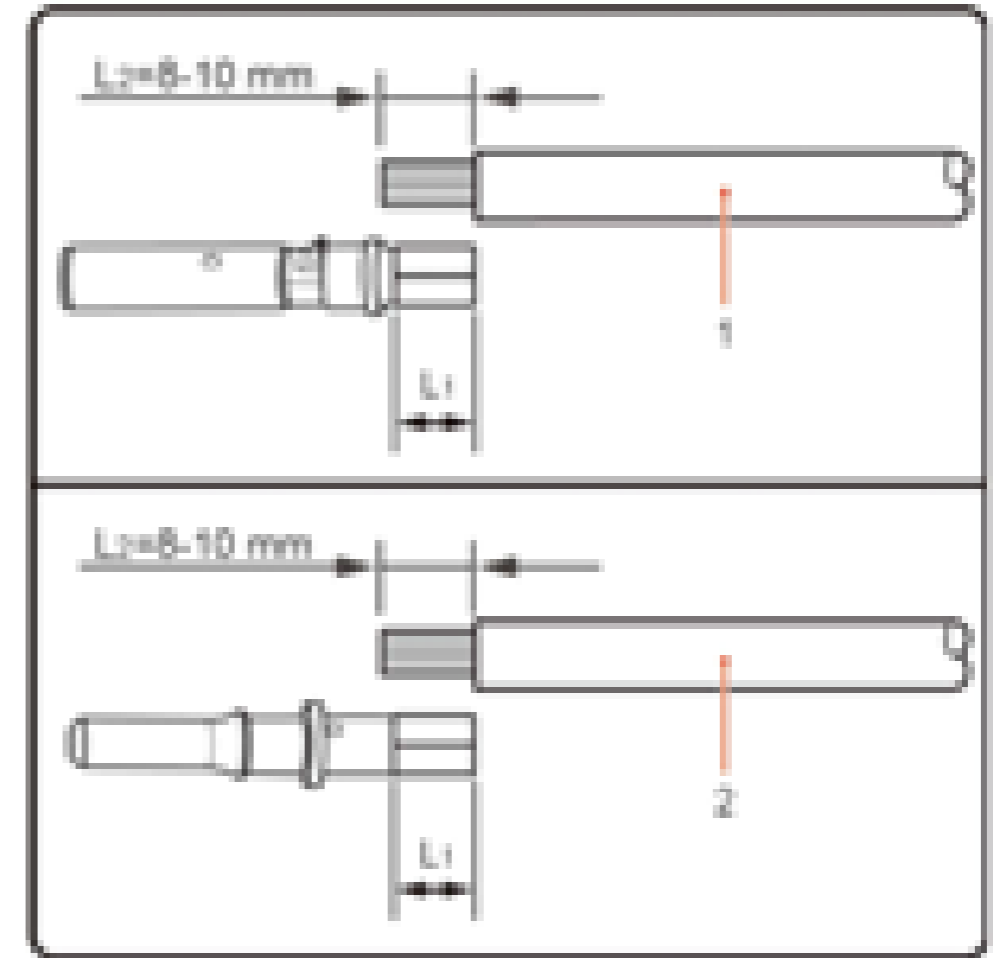
Positive and negative metal terminals are packed with positive and negative connectors respectively. Separate the positive from negative metal terminals after unpacking the Sofar 10K~15KTL-G2 to avoid confusing the polarities.

### Procedure

**Step 1** Remove cable glands from the positive and negative connectors.

**Step 2** Remove the insulation layer with an appropriate length from the positive and negative power cables by using a wire stripper as show in Figure 4-16.

Figure 4-15 Connecting DC input power cables



1. Positive power cable 2. Negative power cable



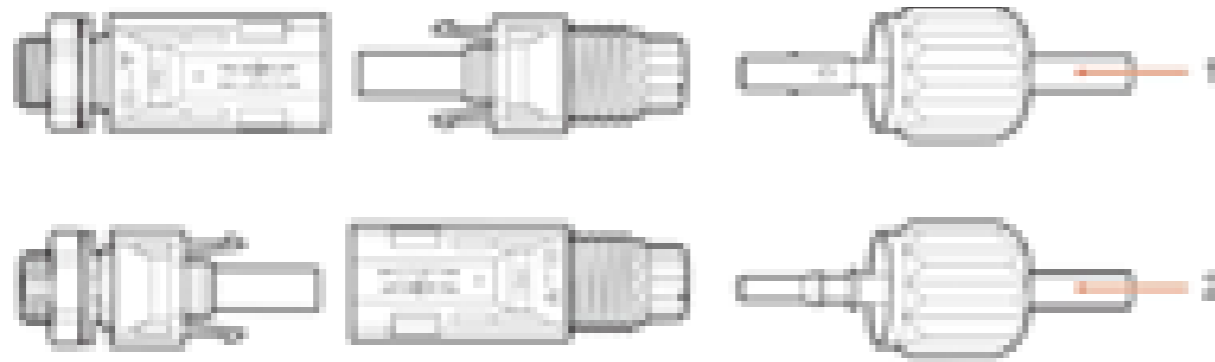
### Note

L2 is 2 to 3 mm longer than L1.

**Step 3** Insert the positive and negative power cables into corresponding cable glands.

**Step 4** Insert the stripped positive and negative power cables into the positive and negative metal terminals respectively and crimp them using a crimping tool. Ensure that the cables are crimped until they cannot be pulled out by force less than 400 N, as shown in Figure 4-17.

Figure 4-16 Connecting DC input power cables



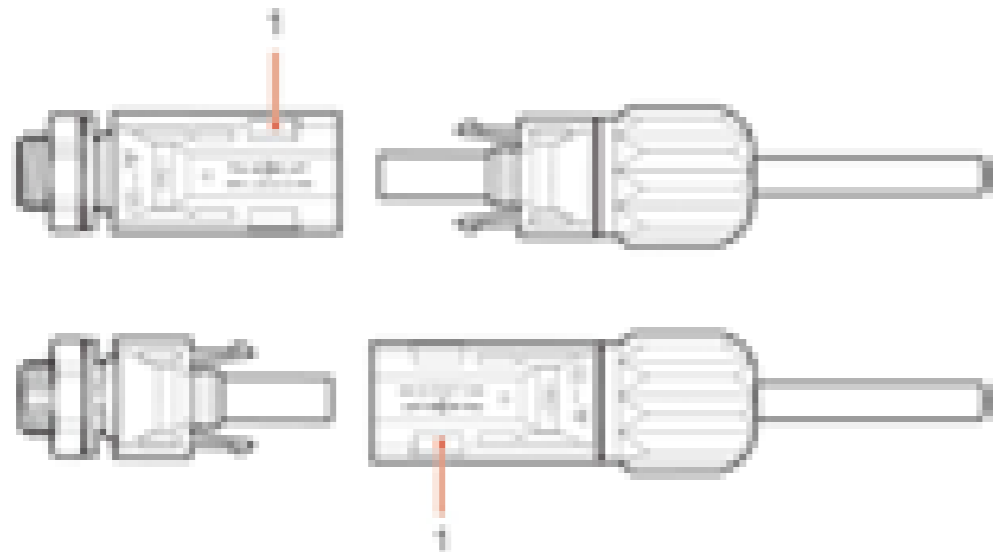
1. Positive power cable    2. Negative power cable

**Step 5** Insert crimped power cables into corresponding housings until you hear a "click" sound. The power cables snap into place.

**Step 6** Reinstall cable glands on positive and negative connectors and rotate them against the insulation covers.

**Step 7** Insert the positive and negative connectors into corresponding DC input terminals of the Sofar 10K~15KTL-G2 until you hear a "click" sound, as shown in Figure 4-17.

Figure 4-17 Connecting DC input power cables



**Follow-up Procedure**

To remove the positive and negative connectors from the Sofar 10K~15KTL-G2, insert a removal wrench into the bayonet and press the wrench with an appropriate strength, as shown in Figure 4-18.


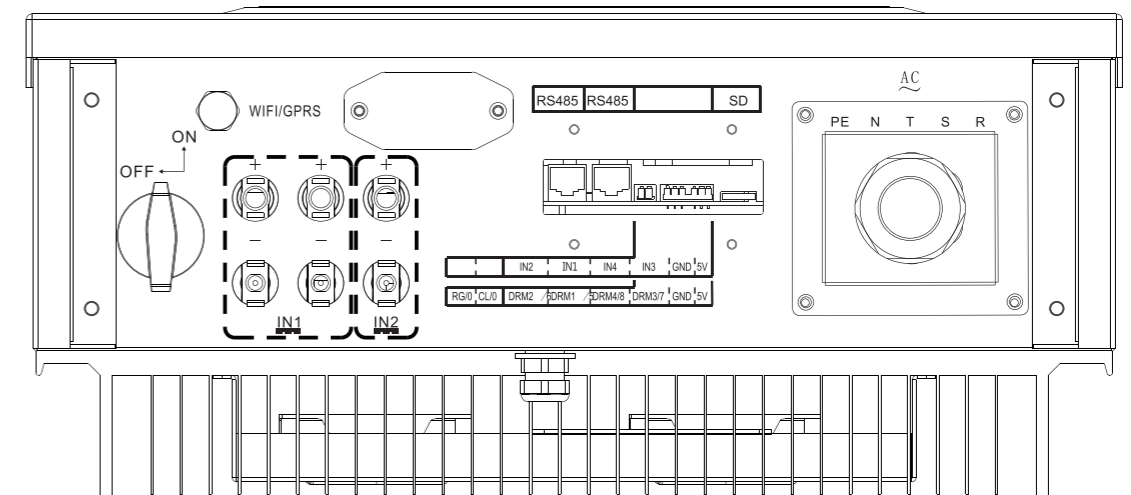
 <b>Caution</b>	<p>Before removing the positive and negative connectors, ensure that the DC SWITCH is OFF.</p>
---	--

Figure 4-18 Removing a DC input connector



## 4.5 DRM Functions

4.5.1 10-15KW-G2 have five TTL input and one 5V Power output witch provided the DRM functions. The Ports are RG/0,CL/0, DRM1/5, DRM2/6, DRM3/7, DRM4/8, and GND ,5V,as shown below :



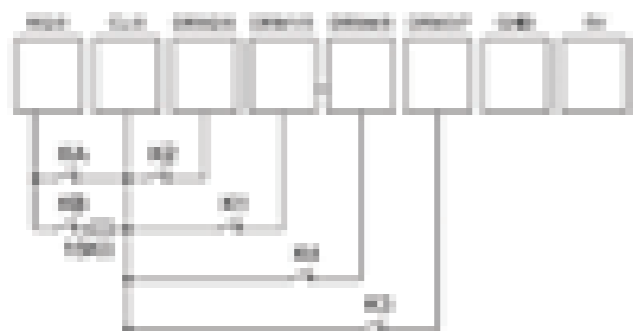
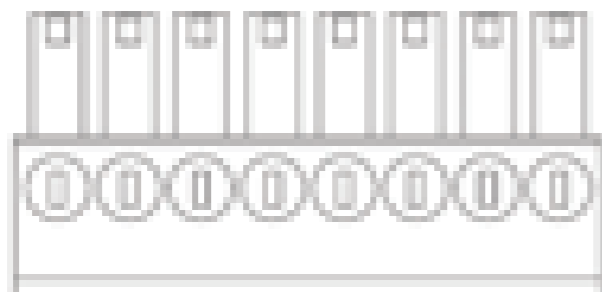
#### 4.5.2 PINs Physical Function Discription :

The DRMs function allocation is shown in below Table:

No.	Pin Name	Description	Connected To
1	NC0	DRM0 input.	Not define. Connected to CL0 with 10kOhm (pull-up/resistor), Or unconnected (Or Connected to-DR0)
2	CL0	DRM0 input Reference	COM (CL0/0). Reference of DRMs
3	DRM1/B	DRM1/B input.	unconnected (Or Connected to-CL0)
4	DRM2/B	DRM2/B input	unconnected (Or Connected to-CL0)
5	DRM3/B	DRM3/B input	unconnected (Or Connected to-DR0)
6	DRM4/C	DRM4/C input	unconnected (Or Connected to-DR0)
7	DR0	Power reference.	Power reference.
8	DR	Dr Power output	output power less than 2.5W.

#### 4.5.3 Enable the DRMs function.

1. Connected the cables as shown below ;



2. Provided the DC Power through the PV Pannel until the LCD is working;
3. Set inverter country code as 02(Australia) in Enter Setting>Set Country Code(password 0001);
4. Enable DRMs function in Enter Setting>DRMs Control(password 0001);
5. Only DRM0, DRM5, DRM6, DRM7, DRM8 has been defined. Inverter will works as DRM0, DRM5, DRM6, DRM7, DRM8 when Corresponding switch closure. Their priority is DRM0>DRM5>DRM6>DRM7>DRM8.


## 4.6 Safety check

1. Check the string polarity
2. Make sure the DC switch is OFF,connect the sting to inverter DC side accordingly
- 3.The string voltage can not be higher than 1000V
4. Check if the connector is fixed well and correctly
5. Check if the PE connection cable and screw is fixed well , check if the communication is connected well(if needed)
6. Check string connection type , if one string is connected to inverter two MPPT, set inverter mode as parallel mode(default is independent mode)
7. Switch on DC switch first ,check if the LCD turned on normally , then turn ON AC switch , inverter should generate power normally, if any abnormal sound, turn off the AC and DC switch. If there is alarm on the inverter , check the manual for trouble shooting.



# 5 Commissioning of inverter

## 5.1 Safety inspection before commissioning

 <b>Attention</b>	<p>Ensure that DC and AC voltages are within the range permitted by the inverter.</p>
---	---

## 5.2 Start inverter

**Step 1** Turn on DC switch.

**Step 2** Turn on AC switch.

When the solar arrays generate adequate power, the inverter will startup automatically. Display showing “normal” indicates correct operation.

**Step 3:** Choose the correct country code. (refer to section 6.3 of this manual)

Notice: Different distribution network operators in different countries have different requirements regarding grid connections of PV grid connected inverters.

Therefore, it's very important to make sure that you have selected the correct country code according to requirements of local authority.

Please consult qualified electrical engineer or personnel from electrical safety authorities about this.

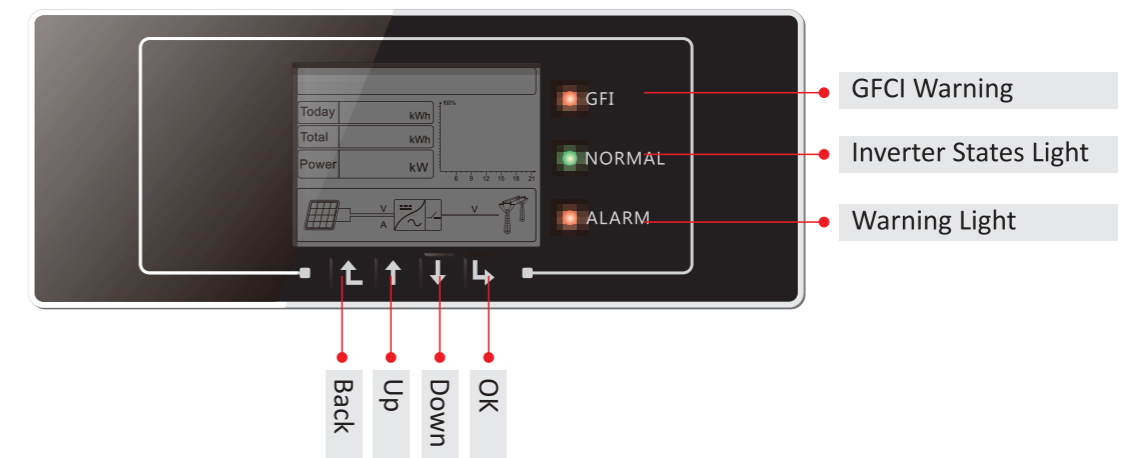
Shenzhen SOFARSOLAR Co., Ltd. is not responsible for any consequences arising out of incorrect country code selection.

If the inverter indicates any other fault, please refer to part 7—error messages for help.





# 6 Operation interface

## 6.1 Operation and Display Panel

- Buttons and Indicator lights



### Key-button:

- Back : to back up or enter into main interface at standard interface states
- Up : to move up or increase value
- Down : to move down or decrease value
- Enter : to confirm selection

### Indicator Lights:

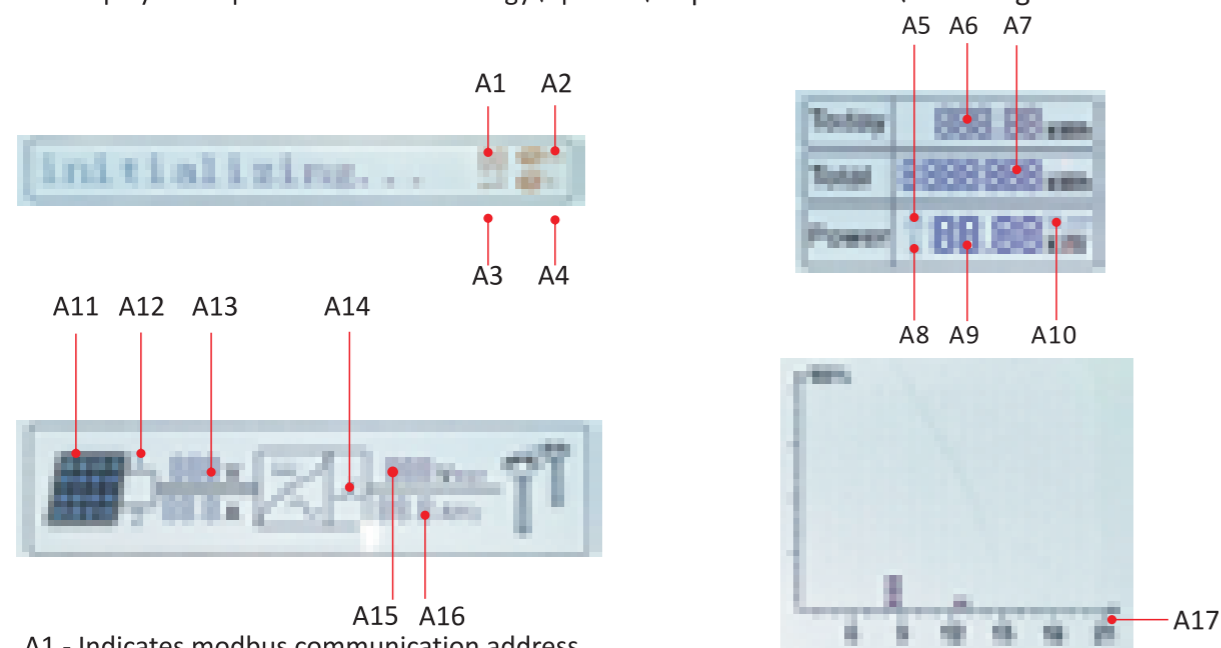
- States Light(GREEN)
  - Flashing: Waiting or checking state
  - ON: Normal operation
  - OFF: Fault or permanent state
- Warning Light (RED)
  - Flashing: Fans fault
  - ON: The inverter is faulty
  - OFF: Normal operation
- GFCI Warning Light (RED)
  - ON: GFCI fault
  - OFF: GFCI normal

## 6.2 Standard Interface

LCD standard interface is used to display inverter states, information and parameter setting etc.

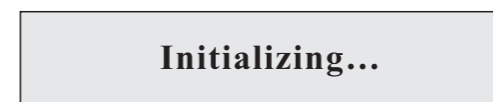


LCD displays the updates of inverter energy, power, input information, warning information etc



- A1 - Indicates modbus communication address.
- A2 - RS485 communicating
- A3 - Light ON for RS485 communicating
- A4 - WIFI communicating
- A5 - Light flashes to warn over frequency and power derating. Light ON to warn remote off
- A6 - Indicates today's energy
- A7 - Indicates the total energy
- A8 - Light ON warning for inverter high temperature
- A9 - Indicates real time output power
- A10 - MPPT SCAN function is activated (not available)
- A11 - Light ON when input voltage over 160V
- A12 - Indicates real time input voltage and current channel
- A13 - Indicates the input voltage and current of phase 1&2 and displays in turns in every three seconds
- A14 - Light ON when the state is normal
- A15 - Indicates R/T/S phase voltage and displays in turns in every three seconds
- A16 - Indicates R/T/S phase current or frequency and displays in turns in every three seconds
- A17 - Indicates the energy from 3:00am-21:00pm in the day

When power-on, LCD interface displays INITIALIZING, refer below picture.



when control board successfully connected with communication board, the LCD display the current state of the inverter, display as shown in the figure below.



Waiting States, Countdown 10S



Checking



Normal Power Generation



Regular error state



Unrecoverable error state

### Inverter states includes: wait, check, normal, fault and permanent

**Wait** : Inverter is waiting to Check State at the end of reconnection time. In this state, the PV voltage is more than 180V, grid voltage value is between the max and min limits and so on; If not, Inverter will go to Fault State or Permanent State.

**Check**: Inverter is checking isolation resistor, relays, and other safety requirements. It also does self-test to ensure inverter software and hardware are functional. Inverter will go to Fault State or Permanent State if any error or fault occurs.

**Normal** : Inverter enter to Normal State, it is feeding power to the grid; inverter will go to Fault State or Permanent state if any error or fault occurs.

**Fault** : Fault State: Inverter has encountered recoverable error. It should recover if the errors disappear. If Fault State continues; please check the inverter according error code.

**Permanent** : Inverter has encountered unrecoverable error, we need maintainer debug this kind of error according to error code.

When the control board and communication board connection fails, the LCD display interface as shown in the figure below.



### 6.3 Main Interface

Press “Back” button under standard interface to enter into main interface, including:

<b>Normal</b>	• Key“Back”
<b>1. Enter Setting</b>	
<b>2. EventList</b>	
<b>3. SystemInfo</b>	
<b>4. System Time</b>	
<b>5. Software Update</b>	

#### (A) “Enter Setting” Interface as below:

<b>1.Enter Setting</b>
<b>1. Set time</b>
<b>2. Clear Energy</b>
<b>3. Clear Events</b>
<b>4. Set Country Code</b>
<b>5. On-Off Control</b>
<b>6. Enset Country</b>
<b>7. Set Energy</b>
<b>8. Set Address</b>
<b>9. Set Inputmode</b>
<b>10. Set Language</b>
<b>11. Set StartPara</b>
<b>12. Set SafetyVolt</b>
<b>13. Set SafetyFreq</b>
<b>14. Set Insulation</b>
<b>15. Set Reactive</b>
<b>16. Set PowerDerat</b>
<b>17. PE Linecontrol</b>
<b>18. Set RefluxP</b>
<b>19. DRMS0 Control</b>
<b>20. Set PowerRatio</b>
<b>21. Autotest Fast</b>
<b>22. Autotest STD</b>

◆ **Set Time**

Users press “Back” button to enter “1.Enter Setting” interface, Press “OK” button to enter main setting interface. Enter “1. Set Time” by pressing“Up” button or “Down” button, then press”OK“button and start to set up time.

Time set from year, month, day, minutes, and seconds in turns, “Up” button or “Down”button to choose different value to set each date. Set each value is need to press “OK” button to confirm setting. “success” is displayed if the setting time is correct, “fail” means failure settings.